

**SINGER**  
**61W16,W107**

# LIST OF PARTS



## MACHINES Nos. 61w16 and 61w107

THE SINGER MANUFACTURING COMPANY

### INDEX

	PAGE
ACCESSORIES .....	17
BINDERS .....	22
BOBBIN WINDER .....	17
FEED DOGS .....	20
KNEE LIFTER .....	18 19
MACHINE No. 61w16 .....	7
"    "    61w107 .....	16
NUMERICAL LIST OF PARTS .....	27
OBSOLETE PARTS .....	24
PRESSER FEET .....	20
RIBBON REELS .....	23
THROAT PLATES .....	21

From the library of: **Edmond Needs Corp**

# Instructions for Ordering

In ordering from this list, use **ONLY** the **PART** number in the **FIRST** column.

The number stamped on a Sewing Machine Part is the number of the Single Part only, except when the part includes Set Screws, Clamping Screws, Studs and Rollers Spun on, Small Wires riveted, or Parts soldered together, etc., which it is necessary to furnish in combination.

Every combination of parts sent out has its specific number which, although not stamped on Parts (except in above cases) must be used when ordering the combination.

Each number always indicates the **SAME PART** in whatever list it appears, or for whatever Machine.

The letters after some of the numbers indicate the style of finish only, as follows:

- A. Hardened, Polished and Plated.
- B. Polished and Plated.
- C. Hardened only.
- D. Polished only.
- E. Soft, not polished.
- F. Hardened and Polished.
- H. Blued.

These letters **MUST BE USED** when they appear in the list and **AFTER** the number, as in the list.

In this series

200001 to 201500 are Screw Numbers.

201501 to 201800 are Nut Numbers.

201801 to 202000 are Roller Numbers.

202001 and upward are numbers of Machine Parts.

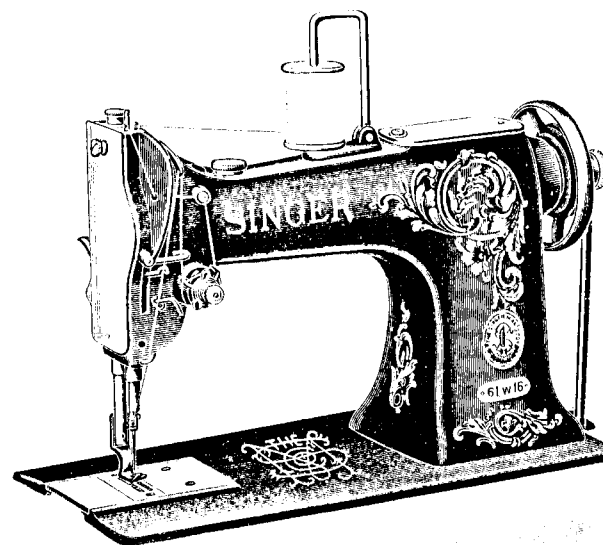
The figures in the second column refer only to the plate in which the illustration of the part is shown and are **NOT TO BE USED** in ordering.

Two or more numbers over a cut indicate that the difference between such parts is not visible in an illustration.

Parts marked with an asterisk (\*) are furnished only when repairs are made at the factory.

## LIST OF PARTS COMPLETE

FOR



## MACHINE No. 61w16

HAS MECHANICAL OPENER

For Tailoring, Overalls, Canvas, Tennis Shoes, Etc.

No.	Plate	Name
*202242	—	Arm .....
202247	10667	" Cap .....
200278n	10244	" " Screw .....
202248	10244	" " " Washer .....
204235	10668	" Position Pin (2) .....
200010e	10245	" Screw (3) .....
202005	10245	" " Washer (3) .....
202249	13351	" Shaft with 200357e and 203100
202243	13364	" " Bushing (back) with
		202244 .....
202244	—	Arm Shaft Bushing (back) Oil
		Packing (wick) .....
200338c	10244	Arm Shaft Bushing (back) Set
		Screw .....
202245	10667	Arm Shaft Bushing (front) with
		202036 and 202260 .....

From the library of: Diamond Needle Corp

No.	Plate	Name
202260	—	Arm Shaft Bushing (front) Oil Packing (wick) .....
200502B	10246	Arm Shaft Bushing (front) Oil Packing Thumb Screw .....
202036	10668	Arm Shaft Bushing (front) Position Pin .....
200338c	10244	Arm Shaft Bushing (front) Set Screw .....
202530	13364	Arm Shaft Connection Belt .....
202252	10244	" " " " Pulley with 200327c, 200602E and two 202253 .....
200602E	10244	Arm Shaft Connection Belt Pulley Position Screw .....
200327c	10244	Arm Shaft Connection Belt Pulley Set Screw .....
202253	10244	Arm Shaft Connection Belt Pulley Spring Flange .....
203100	—	Arm Shaft Oil Packing (wick) ....
200357E	10244	" " " " Stop Screw .....
202255	13364	Balance Wheel (belt groove 2½ in. diam.) with 200328c and 200335c .....
200328c	10244	Balance Wheel Position Screw ...
200335c	10244	" " Set Screw .....
*202532	—	Bed with 202872 .....
202258	12153	" Hinge Connection (2) .....
200570E	10245	" " " Screw (4) ....
206753	13364	" Plate (back) .....
200577H	10245	" " " Screw .....
210616	10667	" Slide (front) .....
202265	11671	Bobbin .....
207057	13363	" Case Base .....
206733	—	" " Cap with 200592c, 201016c and 206738 .....
206734	13363	Bobbin Case Cap complete, Nos. 200964c, 206733, 206736 and 210736 .....
206735	13363	Bobbin Case Latch .....
206736	—	" " " 206735 with 206731 and 206737 .....
206731	13363	Bobbin Case Latch Fulcrum Pin ..
206737	13363	" " " Lever .....
210736	13363	" " " Spring .....
200964c	13363	" " " Stop Screw ...
206738	13363	" " Tension Spring .....
201016c	13363	" " " " Regulating Screw .....
200592c	13363	Bobbin Case Tension Spring Screw

No.	Plate	Name
207058	13363	Bobbin Case complete, Nos. 206734 and 207057 .....
202500	10273	Bobbin Case Lever .....
202501	10273	" " " Bushing .....
200333c	10273	" " " " Set Screw .....
206764	13363	" " " Driving Eccentric with 200380c and 200444c..
206763	—	Bobbin Case Lever Driving Eccentric 206764 with 200583H and 206761 .....
206728	13363	Bobbin Case Lever Driving Eccentric Connection .....
206729	—	Bobbin Case Lever Driving Eccentric Connection 206728 with 201194c, 201524c, 206758 and 206763 .....
206730	13363	Bobbin Case Lever Driving Eccentric Connection Lever with 200086c .....
201194c	13363	Bobbin Case Lever Driving Eccentric Connection Lever Hinge Screw Stud .....
201524c	13363	Bobbin Case Lever Driving Eccentric Connection Lever Hinge Screw Stud Nut .....
206758	—	Bobbin Case Lever Driving Eccentric Connection Lever Oil Wick .....
200086c	10248	Bobbin Case Lever Driving Eccentric Connection Lever Pinch Screw .....
200380c	10272	Bobbin Case Lever Driving Eccentric Set Screw .....
200444c	10273	Bobbin Case Lever Driving Eccentric Spot Screw .....
206761	13363	Bobbin Case Lever Driving Eccentric Washer .....
200583H	10668	Bobbin Case Lever Driving Eccentric Washer Screw .....
207059	—	Bobbin Case Outfit complete, Nos. 200333c, 202500, 202501, 206729, 206730 and 207058 .....
200459D	13353	Cloth Guide Thumb Screw .....
202274	10667	Face Plate .....
202135	10245	" " Position Pin .....
200462B	10245	" " Thumb Screw .....
202275	10667	Feed Bar .....
200641c	10246	" " Hinge Screw (driving)..
201522E	10246	" " " " Nut .....
202276	10245	" " Slide Block .....

No.	Plate	Name
202298	10245	Feed Bar Slide Block Crank with 200038c .....
203124	—	Feed Bar Slide Block Crank 202298 with 200205E, 201518E and 202276
200038c	10245	Feed Bar Slide Block Crank Pinch Screw .....
200205E	10245	Feed Bar Slide Block Hinge Screw
201518E	10245	" " " " " "
		Nut .....
202288	13367	Feed Dog .....
200106E	10245	" " Screw (2) .....
202297	10667	" Driving Connection with 200054E and 202277 .....
202298	10245	Feed Driving Connection Crank with 200038c .....
200038c	10245	Feed Driving Connection Crank Pinch Screw .....
200545c	10245	Feed Driving Connection Hinge Screw .....
201518E	10245	Feed Driving Connection Hinge Screw Nut .....
202277	—	Feed Driving Connection Oil Packing (wick) .....
200054E	10246	Feed Driving Connection Pinch Screw .....
202300	10246	Feed Driving Eccentric Regulating Bracket .....
203134	—	Feed Driving Eccentric Regulating Bracket 202300 with 202252, two each 201014c and 201525E .....
201014c	10245	Feed Driving Eccentric Regulating Bracket Hinge Screw .....
201525E	10245	Feed Driving Eccentric Regulating Bracket Hinge Screw Nut .....
202301	10246	Feed Driving Eccentric Regulating Bracket Plunger .....
202595	10246	Feed Driving Eccentric Regulating Bracket Plunger Spring .....
200607c	10246	Feed Driving Eccentric Regulating Bracket Plunger Spring Stop Screw .....
201014c	10245	Feed Driving Eccentric Regulating Bracket Stop Screw .....
201525E	10245	Feed Driving Eccentric Regulating Bracket Stop Screw Nut .....
200429c	10246	Feed Driving Eccentric Regulating Screw .....
200383c	10246	Feed Driving Eccentric Regulating Screw Check Screw .....

No.	Plate	Name
202303	13352	Feed Driving Rock Shaft .....
206860	—	" " " " 202303 with 200641c, 201522E and 202275
202305	10245	Feed Driving Rock Shaft Center (2) .....
200043c	10246	Feed Driving Rock Shaft Center Set Screw (2) .....
202306	10667	Feed Lifting Connection with 200054E and 202277 .....
202307	10246	Feed Lifting Connection Eccentric with 200382c and 200437c .....
200437c	10246	Feed Lifting Connection Eccentric Position Screw .....
200382c	13366	Feed Lifting Connection Eccentric Set Screw .....
200545c	10245	Feed Lifting Connection Hinge Screw .....
201518E	10245	Feed Lifting Connection Hinge Screw Nut .....
202277	—	Feed Lifting Connection Oil Packing (wick) .....
200054E	10246	Feed Lifting Connection Pinch Screw .....
202308	13352	Feed Lifting Rock Shaft .....
202305	10245	" " " " Center (2)
200043c	10246	" " " " " " Set Screw (2) .....
207070	13352	Feed Regulating Spindle with 202311, 202443, 202619 and 210554
210554	10668	Feed Regulating Spindle Spring (flat) .....
*202311		Feed Regulating Spindle Head ..
202443	10244	" " " " Pin
202619	10668	" " " " Position Pin .....
*206776		Hook (sewing) .....
206777	13352	" 206776 with 200145H, 200596E, 200614c, 202320, 203101, 206751, 206775 and 206852 .....
207060	13361	Hook and Bobbin Case complete, Nos. 206777 and 207058 .....
206852	13353	Hook Gib .....
200614c	11671	" " Hinge Screw .....
200596E	11671	" " Screw .....
203101	—	" Oil Wick .....
*202320	—	" Shaft, 11 7/8 in. long .....
202321	10245	" " Bushing (back) .....
200346c	10245	" " " " Set Screw
202322	10245	" " " (front) .....
200346c	10245	" " " " Set Screw ..

From the Library of Diamond Feed Co.

No.	Plate	Name
202323	10244	Hook Shaft Connection Belt Pulley with 202324 and two 201018c ...
201018c	13353	Hook Shaft Connection Belt Pulley Set Screw .....
202324	10244	Hook Shaft Connection Belt Pulley Spring Flange .....
202260	—	Hook Shaft Oil Packing (wick) (2)
206775	11671	" " Pin .....
206751	11671	" Washer .....
200145H	11671	" " Screw .....
202445	10936	Knee Lifter Connection Lever with 202446 .....
202786	—	Knee Lifter Connection Lever 202445 with 200224H, 200262H, 202447 and 202449 .....
200224H	10248	Knee Lifter Connection Lever Hinge Screw .....
202447	10936	Knee Lifter Connection Lever Lifting Rod with 202302 .....
202302	10248	Knee Lifter Connection Lever Lifting Rod Cotter Pin .....
202446	10246	Knee Lifter Connection Lever Pin
202449	10936	" " Lifting Lever .....
200262H	10248	" " " " Hinge Screw .....
202326	10248	Needle Bar with 200141F .....
202550	10283	" " Bushing .....
206880	—	" " " 202550 with 202326 .....
200352c	10248	Needle Bar Bushing Set Screw ...
202552	10283	" " Connecting Link ...
202332	10668	" " " " Oil Guard .....
200161b	10247	Needle Bar Connecting Link Oil Guard Screw .....
202333	10248	Needle Bar Connecting Link Stud with 202254 .....
202254	—	Needle Bar Connecting Link Stud Oil Packing (wick) .....
200374c	10668	Needle Bar Connecting Link Stud Set Screw .....
200383c	10246	Needle Bar Connecting Link Stud Set Screw .....
*206891	—	Needle Bar Connecting Stud .....
202329	10248	" " " " 206891 with 200086c and 202330 .....
202330	—	Needle Bar Connecting Stud Oil Packing (wick) .....

No.	Plate	Name
200086c	10248	Needle Bar Connecting Stud Pinch Screw .....
202551	13364	Needle Bar Crank with 200335c, 200374c, 200383c, 200428c and 202333 .....
203771	—	Needle Bar Crank 202551 with 202329, 202398 to 202400 and 202552 .....
203172	10248	Needle Bar Crank Friction Washer
200428c	10248	" " " Position Screw...
200335c	10244	" " " Set Screw .....
200141F	10248	" Set Screw .....
202335	10667	Presser Bar (hollow) with 200074F
207072	10249	" " Bushing .....
200352c	10248	" " " Set Screw ...
202554	10283	" " Lifter .....
200653c	10249	" " " Hinge Screw ...
202553	10283	" " Lifting Releasing Lever Bracket .....
200260b	10249	Presser Bar Lifting Releasing Lever Bracket Guide Screw ...
202342	10249	Presser Bar Lifting Releasing Lever Bracket Spring (spiral) ...
202337	10249	Presser Bar Position Guide ...
202338	10249	" " " " Lever with 200086F .....
200086F	10248	Presser Bar Position Guide Lever Pinch Screw .....
200352c	10248	Presser Bar Position Guide Set Screw .....
202378	13366	Presser Bar Spring (heavy) ...
202346	10249	" " " Stop Rod ...
200492b	10249	" " Thumb Screw (pressure regulating) .....
200475b	10668	Presser Bar Thumb Screw Thumb Set Screw .....
202355	10668	Presser Bar Thumb Screw Thumb Set Screw Packing (brass) ...
202090	13366	Presser Foot Hinge Pin .....
203011	—	" " Plate .....
202924	—	" " Shank .....
229867	13369	Presser Foot (hinged) complete, Nos. 202090, 202924 and 203011 ...
200074F	10249	Presser Foot Screw .....
226057	13366	Quilter Bracket with 200481b ...
200118c	13366	" " Screw .....
200481b	13366	" Thumb Screw .....
202068	12153	Spool Holder Base .....
200575H	10668	" " " Screw .....

No.	Plate	Name
204296	12153	Spool Holder Wire .....
200079H	10668	" " " Hinge Screw ...
204297	12153	Spool Holder complete, Nos. 200079H, 202068 and 204296 .....
202397	10668	Take-up (auxiliary) .....
200842E	10668	" " Screw .....
202398	10247	" Lever .....
202399	10247	" " Driving Stud with 202277 .....
202277	---	Take-up Lever Driving Stud Oil Packing (wick) .....
202400	10247	Take-up Lever Hinge Stud with 202423 .....
202423	---	Take-up Lever Hinge Stud Oil Packing (wick) .....
200383C	10246	Take-up Lever Hinge Stud Set Screw .....
202401	10247	Take-up Lever Oiling Felt .....
200132E	10247	" " " " Screw
202402	10247	Tension Disc (back) .....
202403	10247	" " (front) .....
202404	10247	" Release Plunger .....
202405	10247	" " Washer .....
202407	10881	" Spring .....
200625F	10247	" Stud with 204925 .....
200084F	---	" " Set Screw .....
204925	10668	" " Washer .....
201572B	10881	" Thumb Nut .....
202409	10252	Tension complete, Nos. 200625F, 201572B, 202402, 202403, 202405, 202407 and 202410 .....
202410	10252	Thread Controller Spring .....
202411	10252	" " " Stop .....
200132E	10247	" " " " Screw
202413	10252	" Guide .....
202414	10252	" " .....
202415	10252	" " .....
202417	10252	" " .....
200582H	10252	" " Screw .....
200355H	10272	" " Set Screw .....
200368H	10668	" " " " .....
202091	10252	" Retainer Sleeve .....
202092	10252	" " Spring .....
204058	10252	" " Stud .....
200368H	10668	" " " Set Screw .....
204059	10668	Thread Retainer complete, Nos. 202091, 202092 and 204058 .....

No.	Plate	Name
202826	13368	Throat Plate, 46 elongated needle hole, for needle sizes 20 and 22, with 202534, 202619 and two 200583H .....
202534	10668	Throat Plate Bobbin Case Stop ..
202619	10668	" " " " " Po- sition Pin .....
200583H	10668	Throat Plate Bobbin Case Stop Screw .....
202872	10668	Throat Plate Position Pin .....
200577H	10245	" " Screw (2) .....

## MACHINE No. 61w107

HAS MECHANICAL OPENER

For Tailoring, Overalls, Canvas, Tennis Shoes, Etc.

This Machine is the same as No. 61w16 with the following exceptions:

No.	Plate	Name
*202241	----	Arm, in place of 202242 .....
202250	13365	" Shaft with 200357E and 203100, in place of 202249 .....
*206897	----	Bed with 202872, in place of 202532
202304	13365	Feed Driving Rock Shaft, in place of 202303 .....
203122	----	Feed Driving Rock Shaft 202304 with 200641c, 201522E and 202275, in place of 206860 .....
202654	13365	Feed Lifting Rock Shaft, in place of 202308 .....
206754	13365	Hook 206776 with 200145n, 200596E, 200614c, 202319, 203101, 206751, 206775 and 206852, in place of 206777 .....
207061	13365	Hook and Bobbin Case complete, Nos. 206754 and 207058, in place of 207060 .....
*202319	----	Hook Shaft, 13 $\frac{1}{2}$ in. long, in place of 202320 .....
202732	----	Knee Lifter Connection Lever 202445 with 200224n, 200262n, 202447 and 202448, in place of 202786 .....
202448	10936	Knee Lifter Lifting Lever (long), in place of 202449 .....

## ACCESSORIES

No.	Plate	Name
200157E	13353	Attachment Screw .....
202265	11671	Bobbin (5) .....
*225482	----	" Case Screw Driver Blade ...
*225483	----	" " " " Handle ...
225497	12153	Bobbin Case Screw Driver com- plete, Nos. 225482 and 225483 ...
231337	13353	Cloth Guide .....
226056	13366	Quilter .....
135 x 5	----	Needles, three each, sizes 16 and 18 .....
225180	----	Drip Pan (short) with four wood screws $\frac{1}{2}$ in., No. 5 .....
41400	12153	Machine Rest Pin (wood) .....
36578	12153	Oiler with 36579 .....
36579	12153	" Spout, 3 $\frac{1}{2}$ in. long, with 120417
120417	----	" " Washer .....
*225484	----	Screw Driver Blade .....
*225485	----	" " Handle .....
225498	12153	Screw Driver complete (7 $\frac{1}{2}$ in. long), Nos. 225484 and 225485 ...
225554	12153	Wrench (steel) .....

### BOBBIN WINDER

Swing Automatic, Right Hand.

*225451	----	Bobbin Holder .....
225453	10882	Frame with 202277 and 225438 ...
225454	10882	" Hinge Pin .....
202277	----	" Oil Packing (wick) .....
225438	10882	" " Well Cap .....
225455	10882	" Spring .....
225456	10882	" " Plunger .....
202473	10883	Pulley with 200380c .....
200380c	10272	" Set Screw .....
*225443	----	Spindle .....
225452	10882	" 225443 with 225451 .....
225444	10882	Stop Latch .....
200056E	10882	" " Screw .....
225458	10882	" " Thumb Lever .....
225459	10882	" " " " Hinge Stud
225460	10882	" " " " Joint Stud
202478	10882	" " Trip Lever .....
200299n	10882	" " " " Hinge Screw
225461	10881	Tension Bracket with 201499B ...
200082b	10881	" " Screw .....



No.	Plate	Name
202104	10881	Tension Bracket Screw Washer ...
2102	10881	" Disc .....
202407	10881	" Spring .....
201499B	10881	" Stud .....
201572B	10881	" " Thumb Nut .....
225462	10881	Bobbin Winder Tension Bracket complete. Nos. 201572B, 202407, 225461 and two 2102 .....
225463	10883	Bobbin Winder and Tension Bracket Base .....
225436	10883	Universal Bobbin Winder complete, Nos. 200056F, 200082D, 200299U, 202104, 202473, 202478, 225444, 225452 to 225456, 225458 to 225460, 225462, 225463 and two wood screws $\frac{3}{4}$ in., No. 13, R.H.B. ....

## KNEE LIFTER

227781	10936	Knee Lifter Rock Lever with 200522c and 200529c .....
227782	---	Knee Lifter Rock Lever 227781 with two each 202451 and 202452 .....
227783	---	Knee Lifter Rock Lever 227782 with 202985 and 227784 .....
202453	10936	Knee Lifter Rock Lever Knee Plate with 200526c .....
202985	---	Knee Lifter Rock Lever Knee Plate 202453 with 202455 .....
202455	10936	Knee Lifter Rock Lever Knee Plate Arm (short) .....
200522c	13353	Knee Lifter Rock Lever Knee Plate Arm Set Screw .....
200526c	13353	Knee Lifter Rock Lever Knee Plate Set Screw .....
202451	10936	Knee Lifter Rock Lever Lug with two wood screws $\frac{3}{8}$ in., No. 13H .....
202452	13353	Knee Lifter Rock Lever Lug Hinge Pin .....
227784	10936	Knee Lifter Rock Lever Rod, 3 in. long, with 227785 .....
*227785	---	Knee Lifter Rock Lever Rod Cap or Oil Guard .....
200529c	13353	Knee Lifter Rock Lever Rod Set Screw .....

(Other Knee Lifter Parts are listed with parts of machine head).

## FOR MACHINE NO. 61w107

No.	Plate	Name
Same as for No. 61w16 with the following exceptions:		
225191	---	Drip Pan (long) with four wood screws $\frac{1}{2}$ in., No. 5, in place of 225180 .....

## KNEE LIFTER

227781	10936	Knee Lifter Rock Lever with 200522c and 200529c .....
227782	---	Knee Lifter Rock Lever 227781 with two each 202451 and 202452 .....
227787	---	Knee Lifter Rock Lever 227782 with 202203 and 227784 .....
202453	10936	Knee Lifter Rock Lever Knee Plate with 200526c .....
202203	---	Knee Lifter Rock Lever Knee Plate 202453 with 202454 .....
202454	10936	Knee Lifter Rock Lever Knee Plate Arm (long) .....
200522c	13353	Knee Lifter Rock Lever Knee Plate Arm Set Screw .....
200526c	13353	Knee Lifter Rock Lever Knee Plate Set Screw .....
202451	10936	Knee Lifter Rock Lever Lug with two wood screws $\frac{3}{8}$ in., No. 13H .....
202452	13353	Knee Lifter Rock Lever Lug Hinge Pin .....
227784	10936	Knee Lifter Rock Lever Rod, 3 in. long, with 227785 .....
*227785	---	Knee Lifter Rock Lever Rod Cap or Oil Guard .....
200529c	13353	Knee Lifter Rock Lever Rod Set Screw .....

(Other Knee Lifter Parts are listed with parts of machine head).

## FEED DOGS

No.	Plate	Name
202284	13367	Feed Dog, for 202812 .....
202286	13367	" " " 202821 .....
202288	13367	" " " 202823, 202826 and 203193 .....
226171	13367	Feed Dog, for 226175 and 226190 ..
230598	13367	" " " 203102 .....

## PRESSER FEET

203767	10921	Presser Foot with 202108, for clamping tailoring guide .....
206830	13369	Presser Foot .....
206832	13369	" " .....
207024	13369	" " for binding cardigan jackets .....
202379	10921	Presser Foot Guide .....
202392	10921	" " " (auxiliary foot)
202393	10921	" " " for thick goods
202394	10921	" " " " tucks .....
202395	10921	" " " .....
202396	10921	" " " at left, for tucks
202808	10921	" " " Clamp .....
202799	10921	" " " " Hinge Pin
202763	10921	" " " " Spring
202108	10921	" " " " " "
		Pin .....
203768	10921	Presser Foot complete, Nos. 202379, 202392 to 202396, 202763, 202799, 202808 and 203767, for tailoring
206998	13369	Presser Foot Holder with 200543H, for Presser Bar 202335 as a sub- stitute for Compound Presser Bar 202514 .....
200543H	13369	Presser Foot Screw .....
206842	---	" " Cleft Holder, for Hemmers .....

## THROAT PLATES

No.	Plate	Name
202812	13368	Throat Plate, 46 needle hole, for needle sizes 16 and 18, with 202534, 202619 and two 200583H, for 202284 .....
202821	13368	Throat Plate, 50 needle hole, for needle sizes 14 and 15, with 202534, 202619 and two 200582H, for 202286 .....
202823	13368	Throat Plate, 50 needle hole, for needle sizes 14 and 15, with 202534, 202619 and two 200583H, for overall and tailoring work, for 202288 .....
202826	13368	Throat Plate, 46 elongated needle hole, for needle sizes 20 and 22, with 202534, 202619 and two 200583H, for 202288 .....
203102	13368	Throat Plate, 50 needle hole, for needle sizes 14 and 15, with 202534, 202619 and two 200583H, for mattress binding and similar work, for 230598 .....
203193	13368	Throat Plate, 40 needle hole, for needle sizes 20 and 22, with 202534, 202619 and two 200583H, for 202288 .....
226190	13367	Throat Plate, 50 needle hole, for needle sizes 14 and 15, with 202534, 202619 and two 200583H, for 226171 and 226175 .....
200582H	10252	Throat Plate Bobbin Case Stop Screw .....

## BINDERS

### BINDER

#### For Skirts

No.	Plate	Name
225636	13366	Bias Binder on Shank, folds binding of the following widths: $\frac{5}{8}$ , $\frac{3}{4}$ , $\frac{7}{8}$ , $1$ , $1\frac{1}{8}$ and 1 inch . . . . .

Note: Specify width wanted on order.

### ENGLISH BINDER

#### For Binding Cardigan Jackets with Elastic or Bias Braid.

226171	13367	Feed Dog . . . . .
226172	13366	Binder Head, for tapes or folded strips $\frac{1}{8}$ , $\frac{1}{4}$ , $\frac{3}{8}$ , $\frac{1}{2}$ , $\frac{5}{8}$ , $\frac{3}{4}$ and $\frac{7}{8}$ inch . . . . .
		Note: State width required, send samples of material to be folded and sufficient material to test Binder.
200896B	13366	Binder Thumb Screw . . . . .
226173	13370	Binder complete, Nos. 226172, 230650 and two 200896B . . . . .
230650	13370	Binder Plate with two 226174 and seven 225648 . . . . .
200577H	10245	Binder Plate Screw . . . . .
225648	13366	" Tape Tension Pin . . . . .
226174	13366	" " " " (guard) . . . . .
226175	—	Binder complete, Nos. 200577H, 226171, 226173 and 226190 . . . . .
207024	13369	Presser Foot . . . . .
226190	13367	Throat Plate, 50 needle hole, for needle sizes 14 and 15, with 202534, 202619 and two 200583H . . . . .

## RIBBON REELS

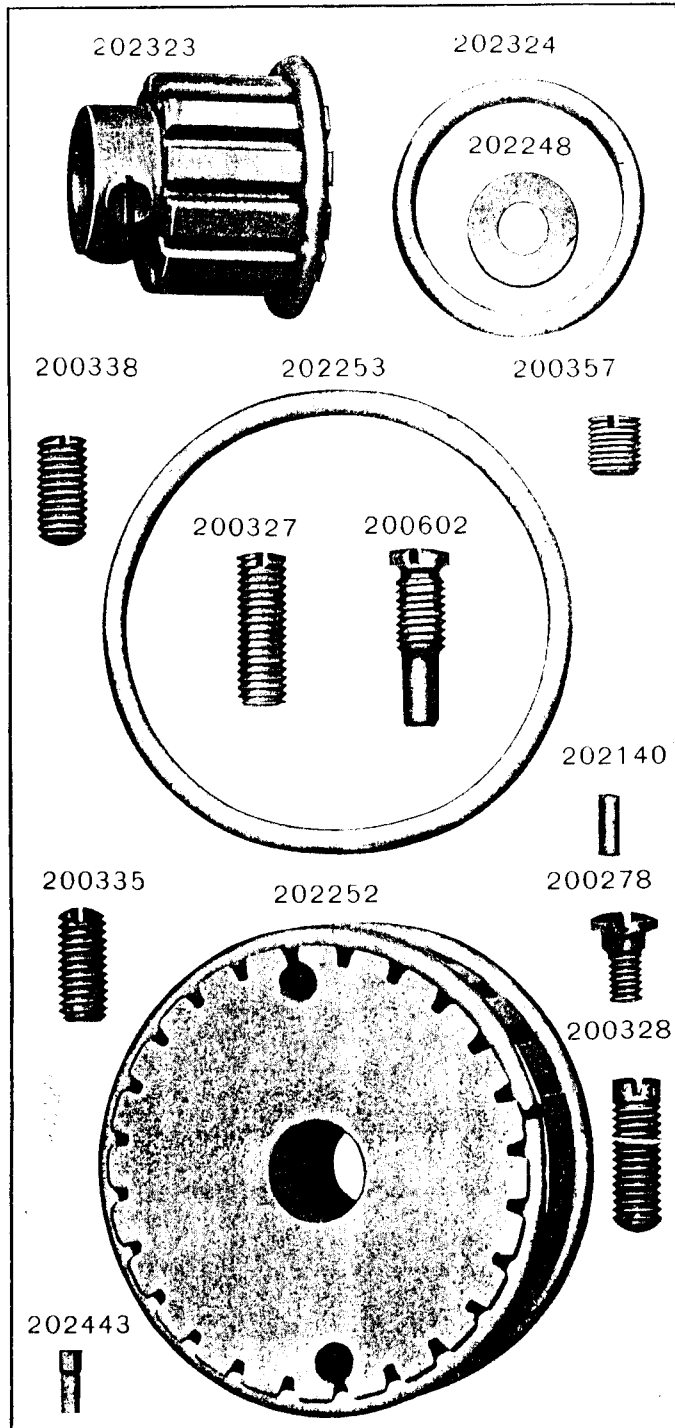
No.	Plate	Name
226200	—	Ribbon Reel (6 in. diam.) with 225666 and three 205520 . . . . .
226211	—	Ribbon Reel (holding projection $6\frac{3}{4}$ in. diam.) with 226212 and 226213 . . . . .
225663	13365	Ribbon Reel (9 in. diam.) with 225666 and three 205520 . . . . .
226212	13366	Ribbon Reel Center Pin . . . . .
226213	13366	" " " " Washer . . . . .
225664	13366	" " Supporting Spindle . . . . .
225665	—	" " " " . . . . .
		Base with 225664 and two wood screws $\frac{3}{8}$ in., No. 7 . . . . .
230471	—	Ribbon Reel Supporting Spindle Hub . . . . .
225666	—	Ribbon Reel Supporting Spindle Hub 230471 with 225980 . . . . .
225980	—	Ribbon Reel Supporting Spindle Hub Base . . . . .
205520	13366	Ribbon Reel Supporting Spindle Hub Base Rivet . . . . .
226201	—	Ribbon Reel (6 in. diam.) complete, Nos. 225665 and 226200 . . . . .
225976	—	Ribbon Reel (9 in. diam.) complete, Nos. 225663 and 225665 . . . . .

## OBSOLETE PARTS

No.	Plate	Name
*202967	--	Bobbin Case .....
202267	11671	" " Latch .....
*202056	----	" " " Pin .....
202269	11671	" " " Plunger .....
202270	11671	" " " Spring .....
202716	11671	" " Tension Spring .....
202796	10273	Bobbin Case complete, Nos. 200594e, 200984e, 202056, 202267, 202269, 202270, 202716 and 202967
202502	10273	Bobbin Case Lever Driving Cam with 200386c and 200444c .....
202503	10273	Bobbin Case Lever Driving Cam Lever with 200086c .....
202504	10273	Bobbin Case Lever Driving Cam Lever Spring (spiral) .....
206760	13363	Bobbin Case Lever Driving Eccen- tric Connection .....
206762	----	Bobbin Case Lever Driving Eccen- tric Connection 206760 with 206763 .....
206759	13363	Bobbin Case Lever Driving Eccen- tric Connection Lever with 200086c and 206758 .....
202841	10273	Bobbin Case Lever complete, Nos. 202500 to 202504 .....
202505	----	Bobbin Case Outfit complete, Nos. 200333c, 202796 and 202841 .....
202470	10271	Bobbin Winder Base .....
202471	10271	" " Frame .....
202472	10271	" " " Spring .....
202474	10271	" " Spindle .....
202475	10272	" " Stop Latch .....
202477	10272	" " " " Thumb Lever .....
202479	10271	Bobbin Winder complete, Nos. 200056e, 200161b, 200221b, 201537u, 202470 to 202475, 202477, 202478, three 200299u and two round head wood screws 1 in., No. 13
202480	10271	Bobbin Winder Spool Holder Base with 200355u and 202484 .....
202481	10271	Bobbin Winder Spool Holder Base Spool Pin .....

No.	Plate	Name
202482	10272	Bobbin Winder Spool Holder Ten- sion Disc (lower or upper) ....
202483	10272	Bobbin Winder Spool Holder Ten- sion Disc Spring (brass) .....
202484	10272	Bobbin Winder Spool Holder Ten- sion Disc Thread Guide .....
202485	10271	Bobbin Winder Spool Holder com- plete, Nos. 200011e, 202480, 202481, 202483, two 202482 and one wood screw 1 in., No. 13 ..
202064	13363	Hook Shaft Pin .....
206780	13353	" Washer .....

PLATE 10244—FULL SIZE



From the library of: Diamond Needle Corp

PLATE 10245—FULL SIZE

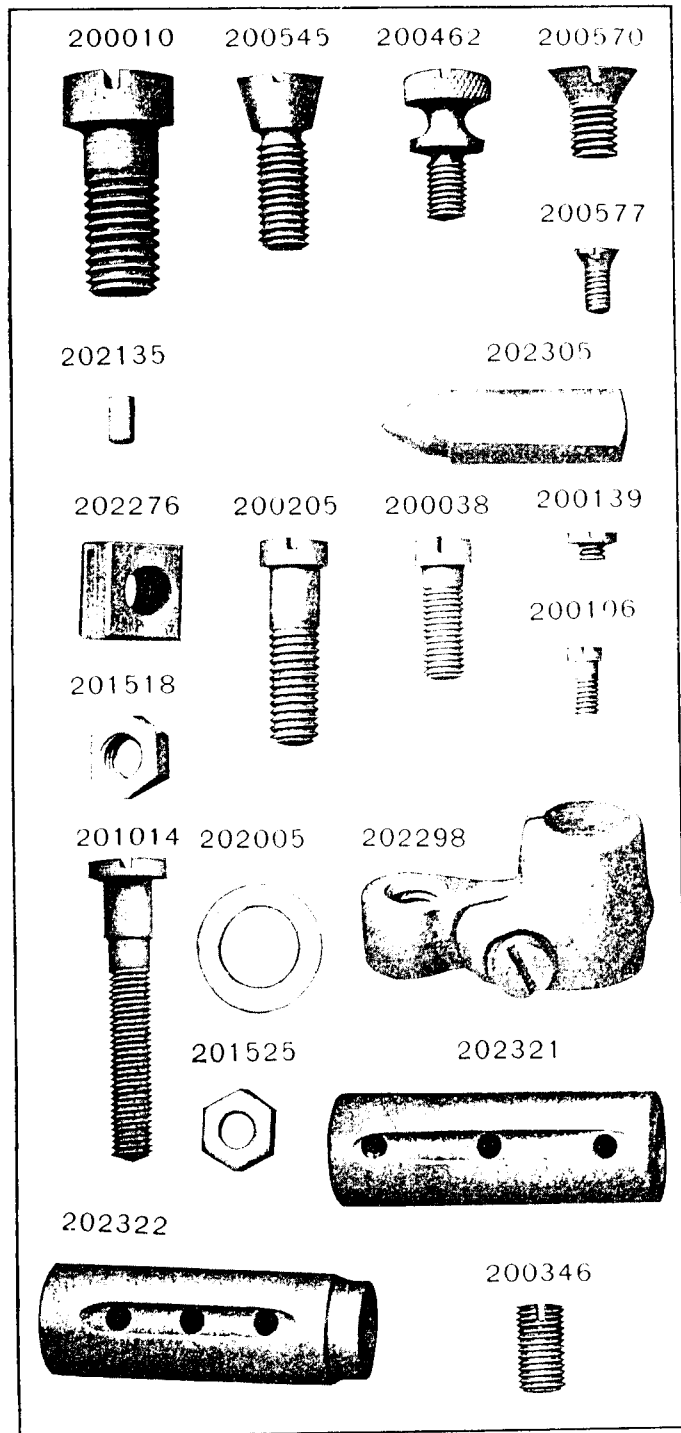


PLATE 10246—FULL SIZE

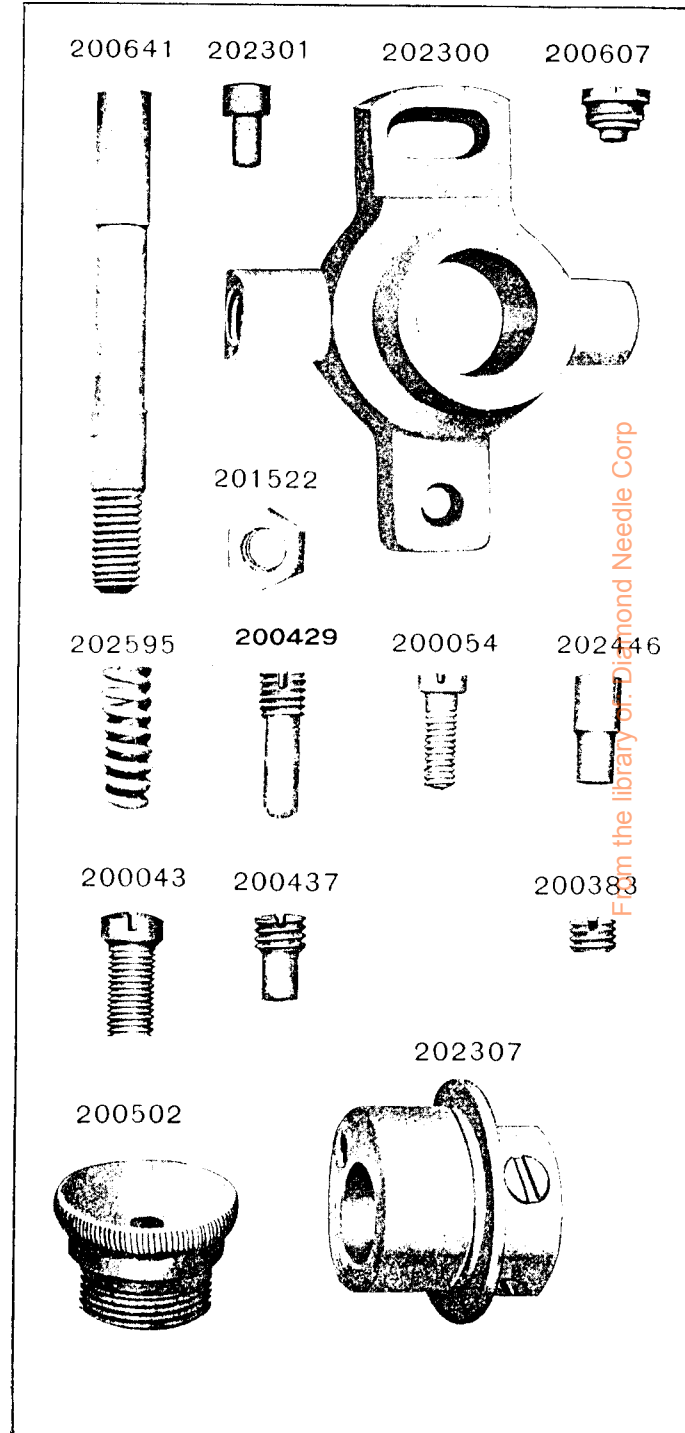


PLATE 10247—FULL SIZE

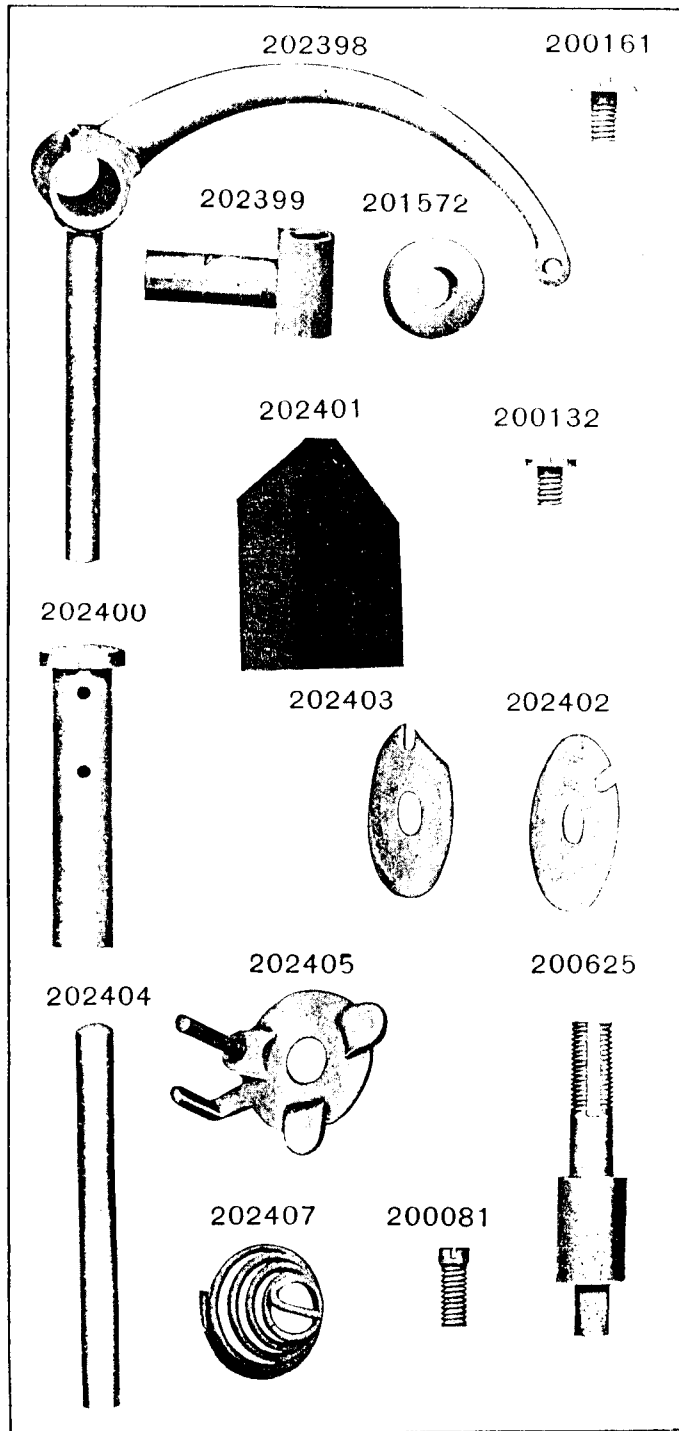
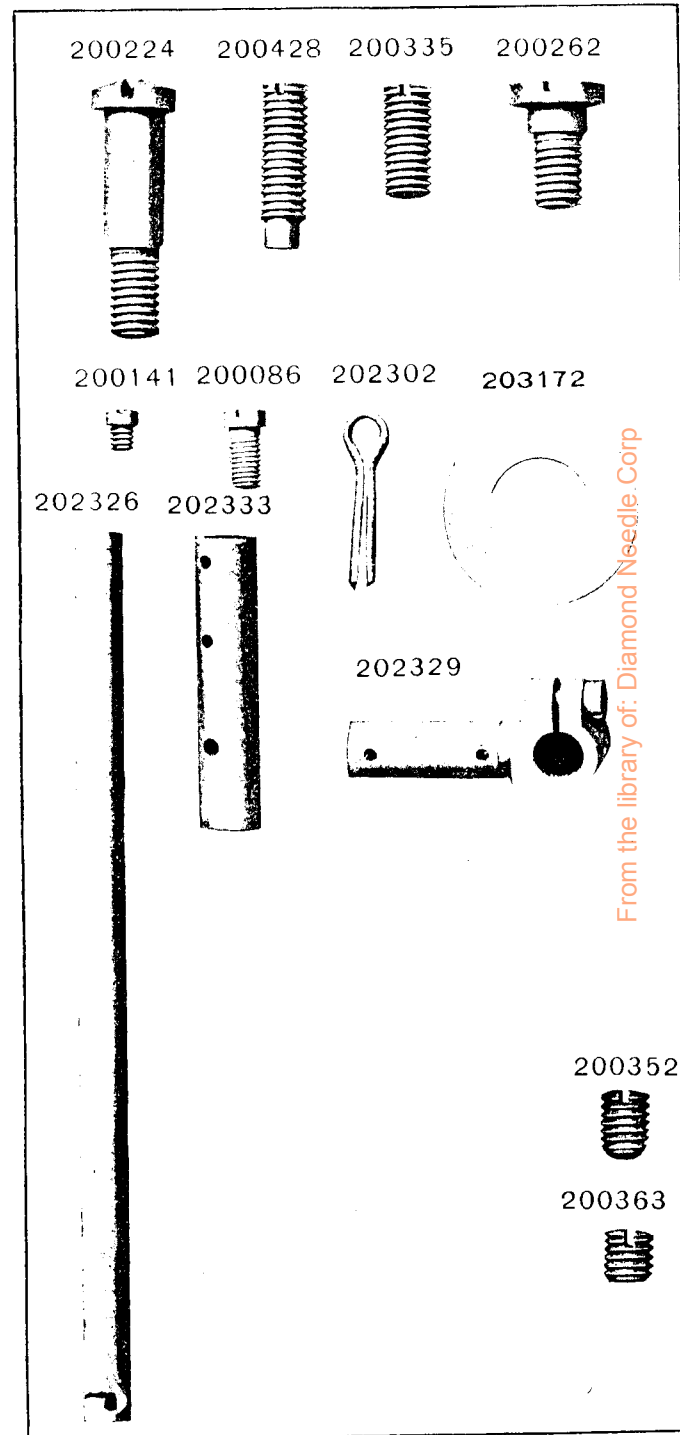


PLATE 10248—FULL SIZE



From the library of: Diamond Needle Corp

PLATE 10249—FULL SIZE

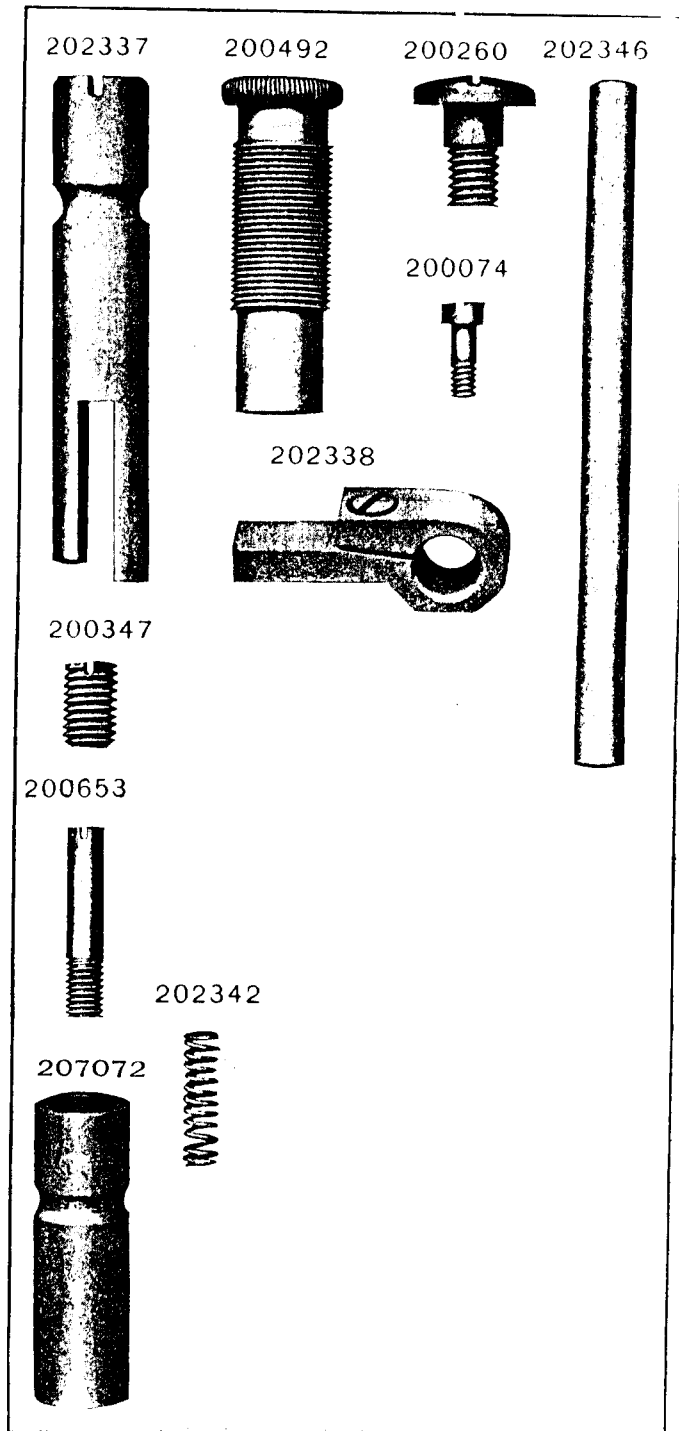
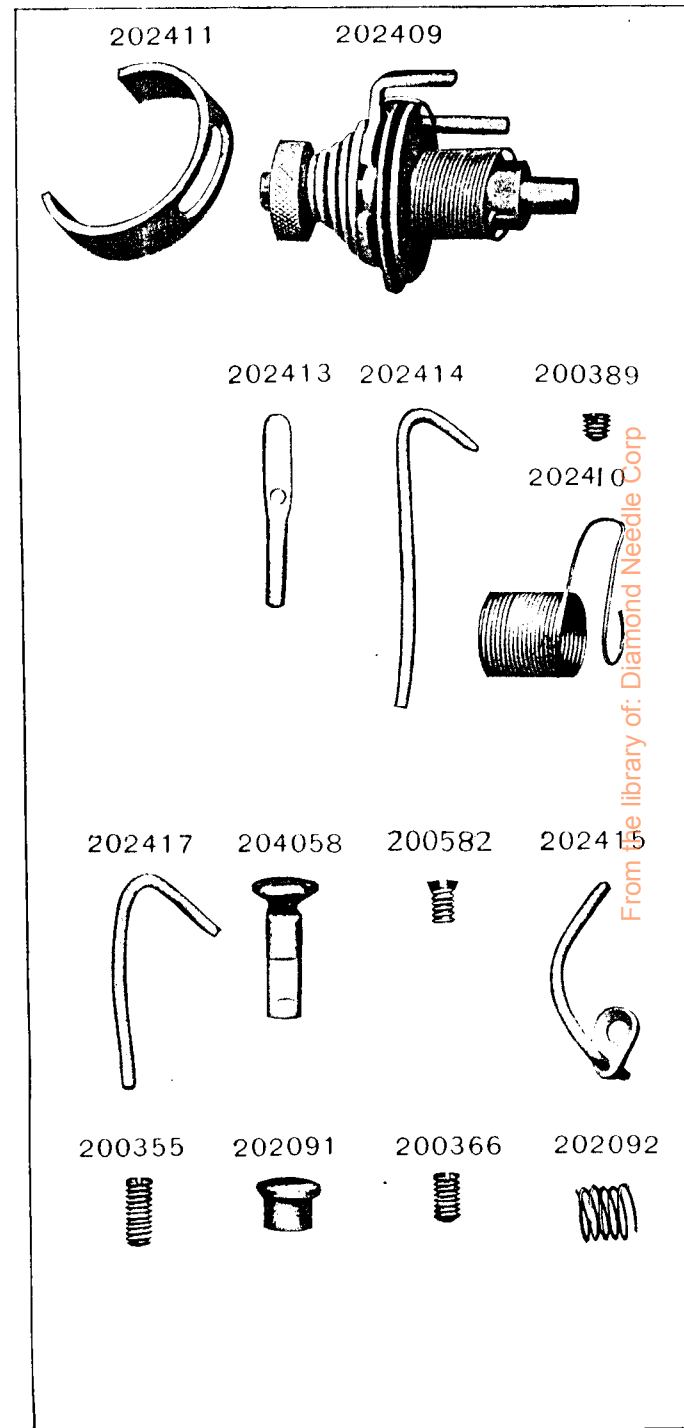


PLATE 10252—FULL SIZE



From the library of: Diamond Needle Corp



PLATE 10271—ONE-HALF SIZE

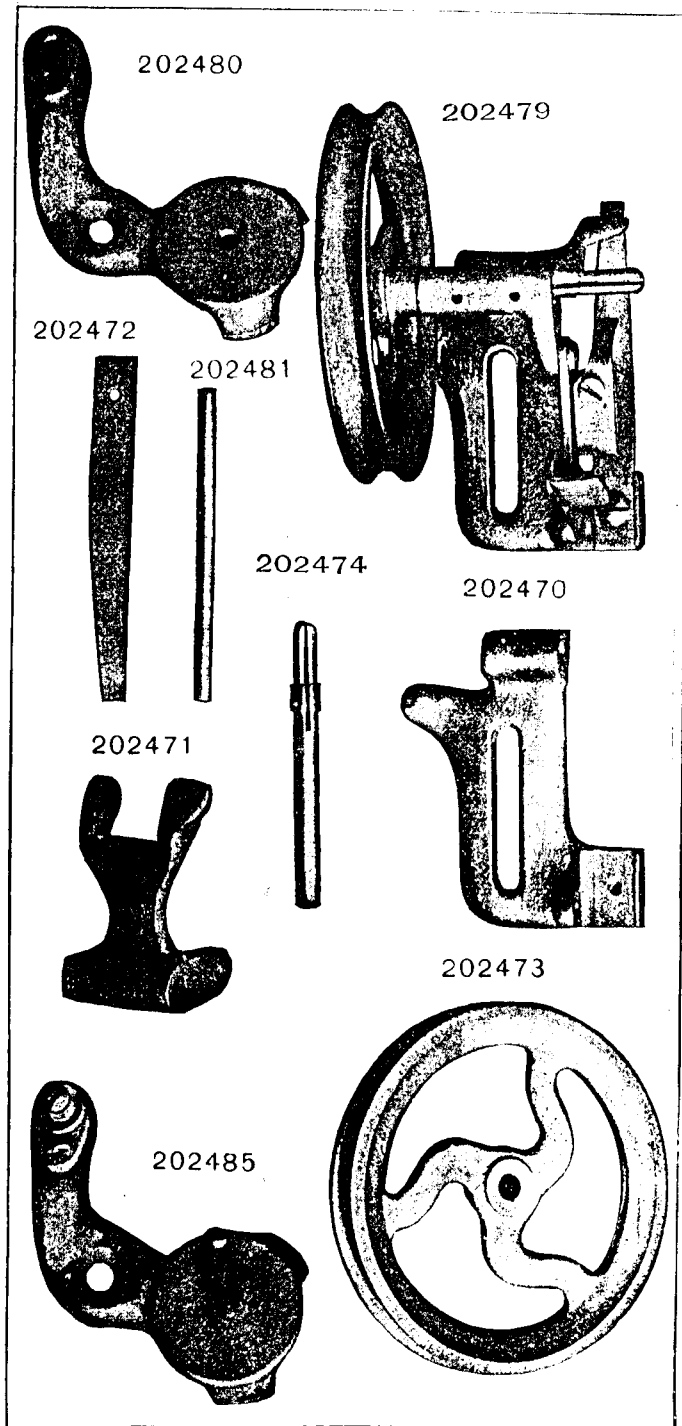
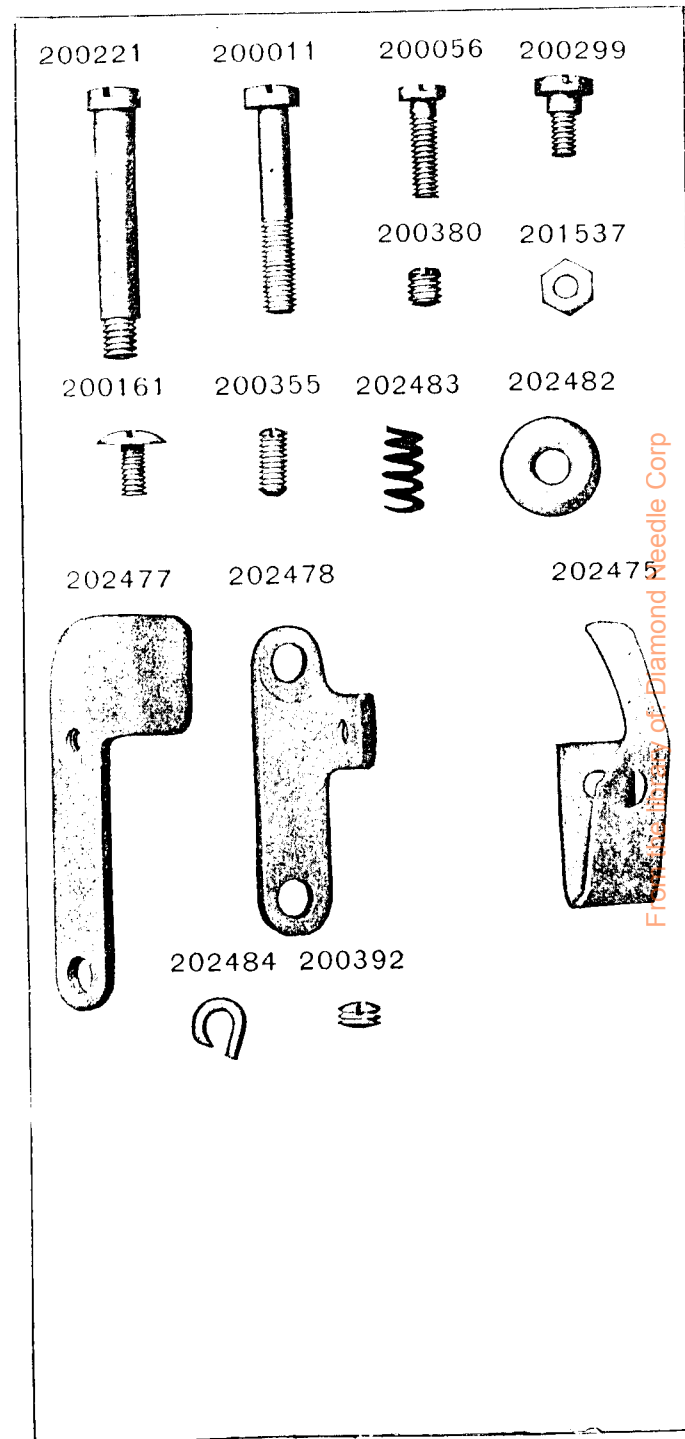


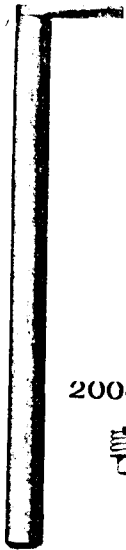
PLATE 10272—FULL SIZE



FURNISHED BY DIAMOND NEEDLE CORP.

PLATE 10273—FULL SIZE

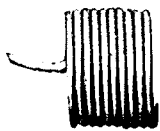
202500



200086



202504



200444



202503



202502



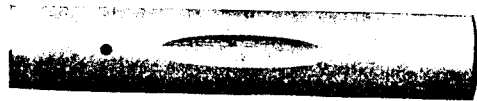
200333



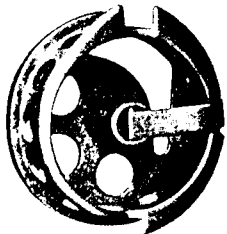
200380



202501



202796



202841

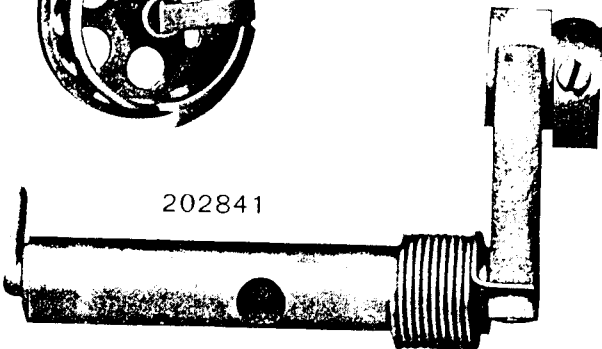
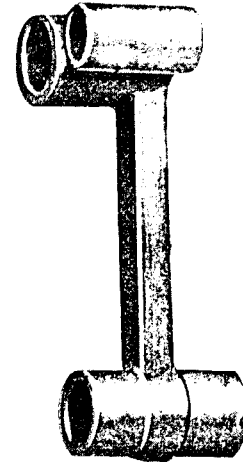


PLATE 10283—FULL SIZE

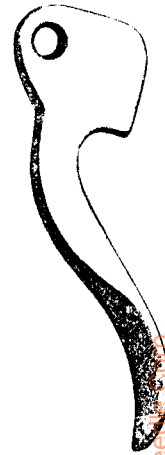
202550



202552



202554



202553

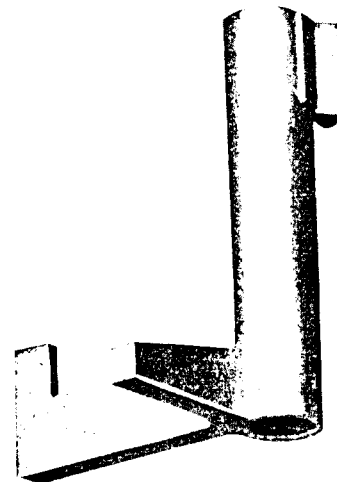


PLATE 10667 - ONE - HALF SIZE

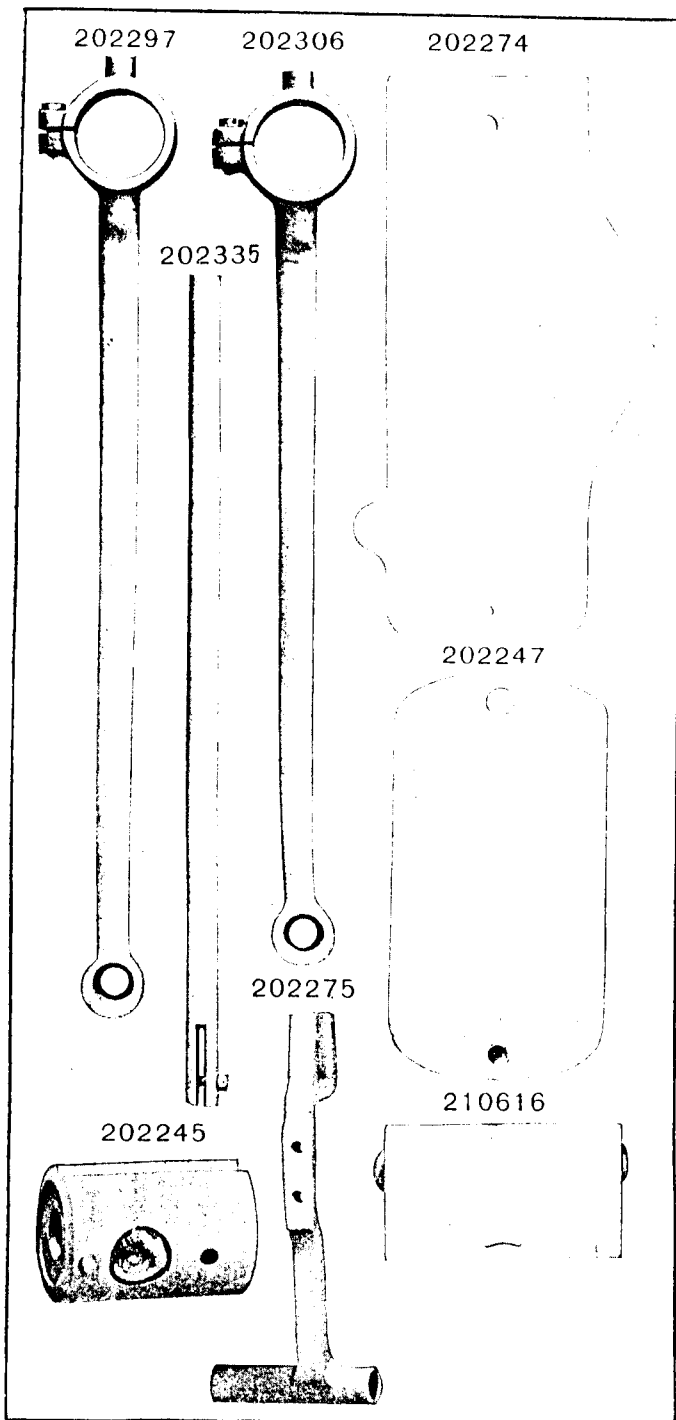
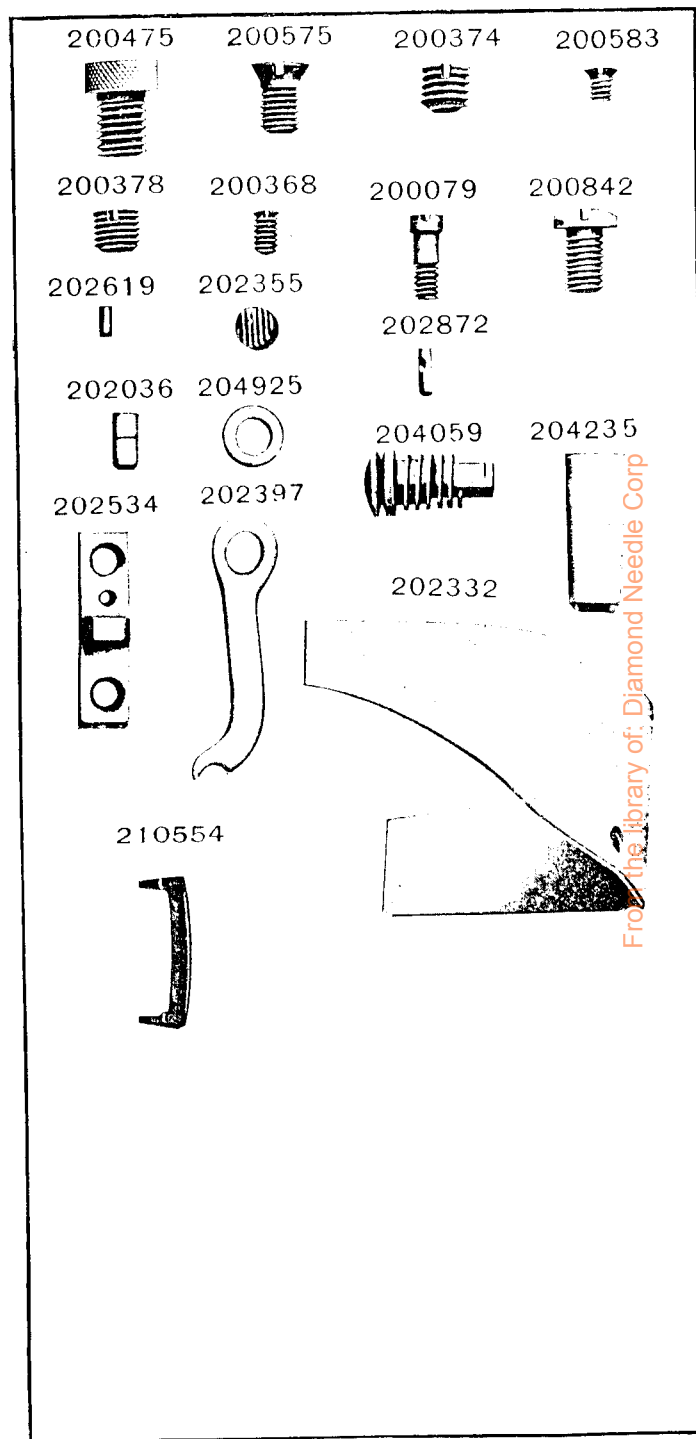


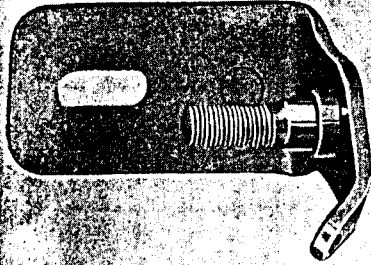
PLATE 10668 - FULL SIZE



From the library of: Diamond Needle Corp

PLATE 10881—FULL SIZE

225461



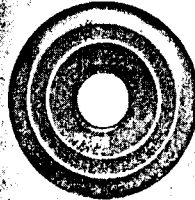
200082



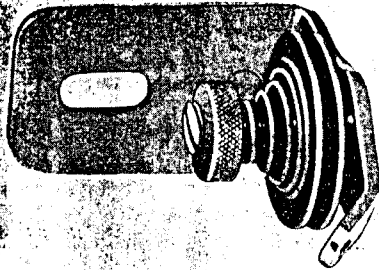
202104



2102



225462



202407



201499



201572



PLATE 10882—FULL SIZE

225453



225455



225438



225457



201052



200056



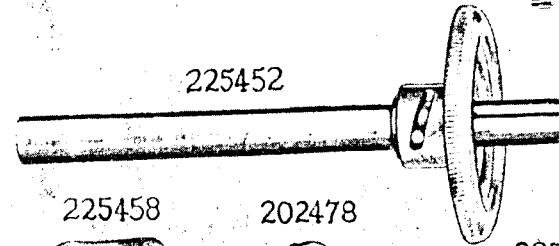
200299



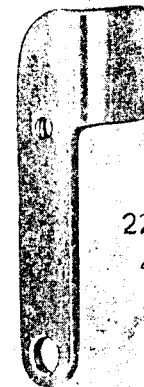
225454



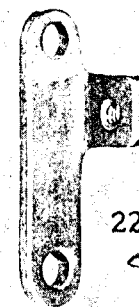
225452



225458



202478



225444



225459



225460



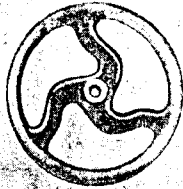
From the library of: Diamond Needle Corp.

PLATE 10883—ONE-FOURTH SIZE

225463



202473



225436

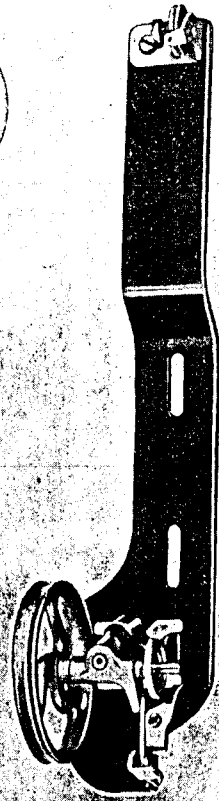
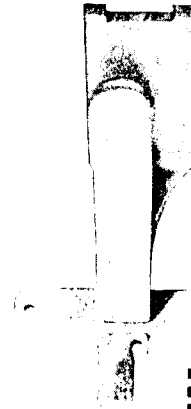
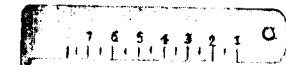


PLATE 10921—FULL SIZE

203768



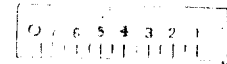
202396



202763



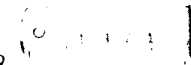
202394



203767



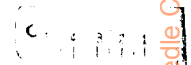
202379



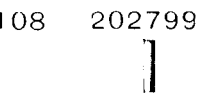
202808



202393



202395



202392



202108



202799



From the library of: Diamond Needle Corp



PLATE 10936 - ONE-FOURTH SIZE

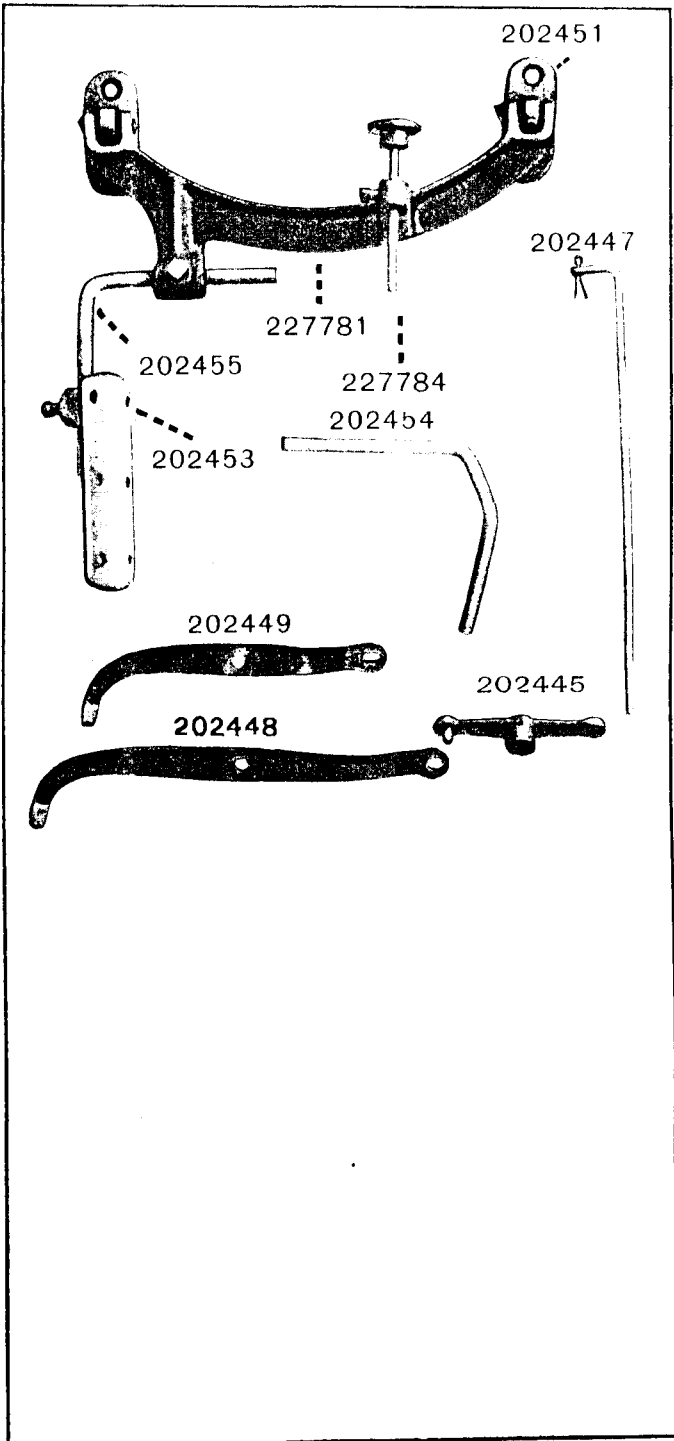
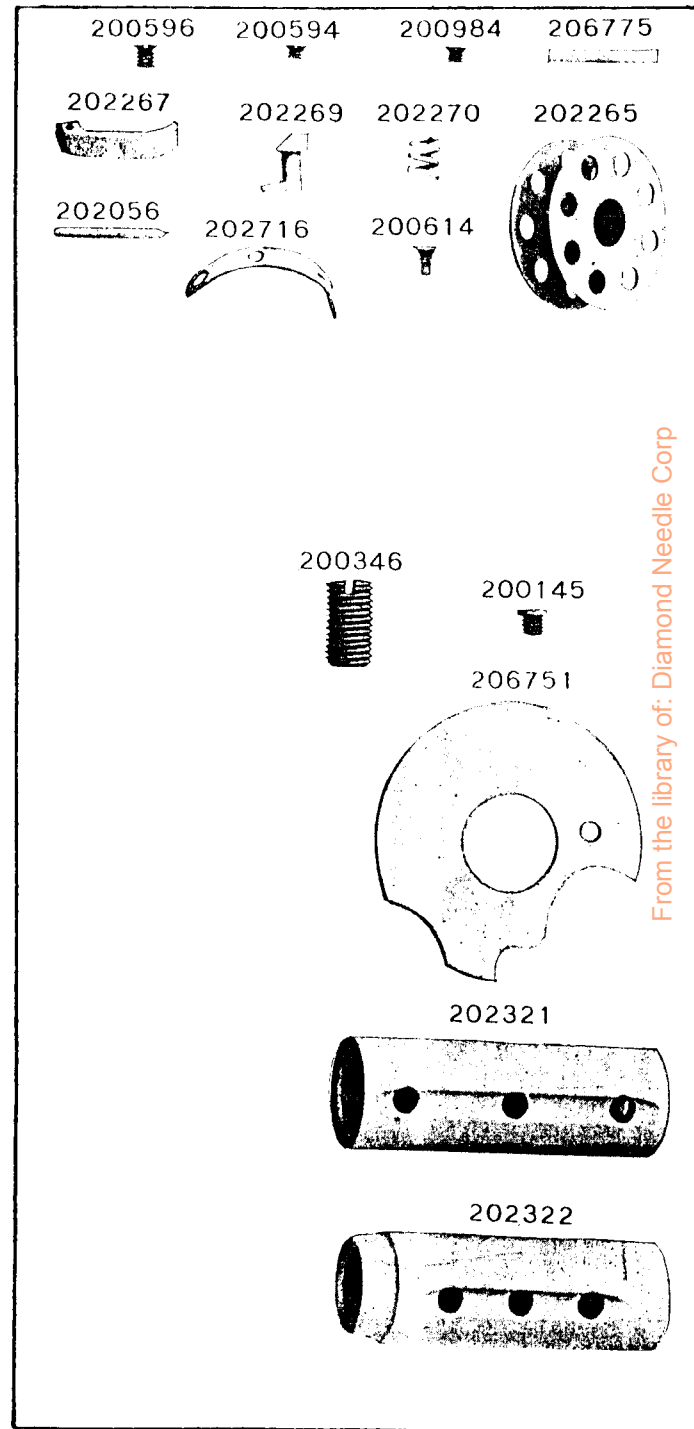


PLATE 11671-FULL SIZE



From the library of: Diamond Needle Corp

PLATE 12153-ONE-HALF SIZE

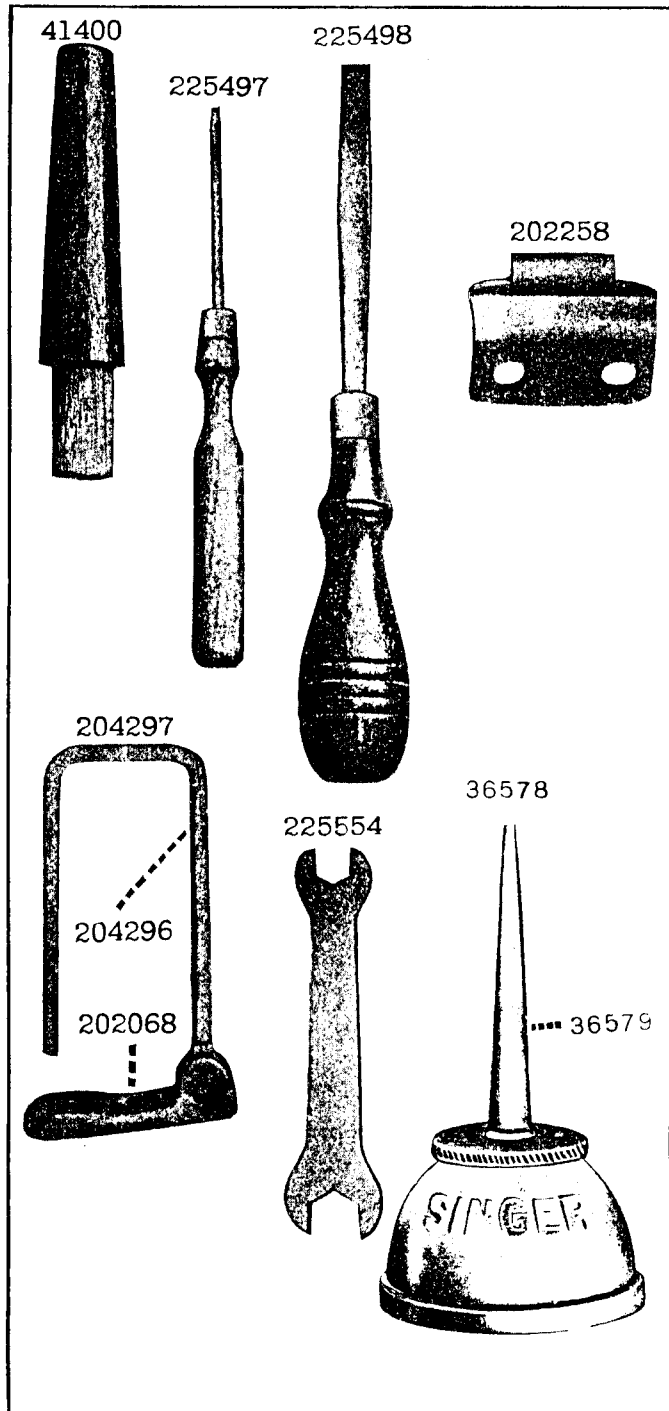


PLATE 13351-ONE-HALF SIZE

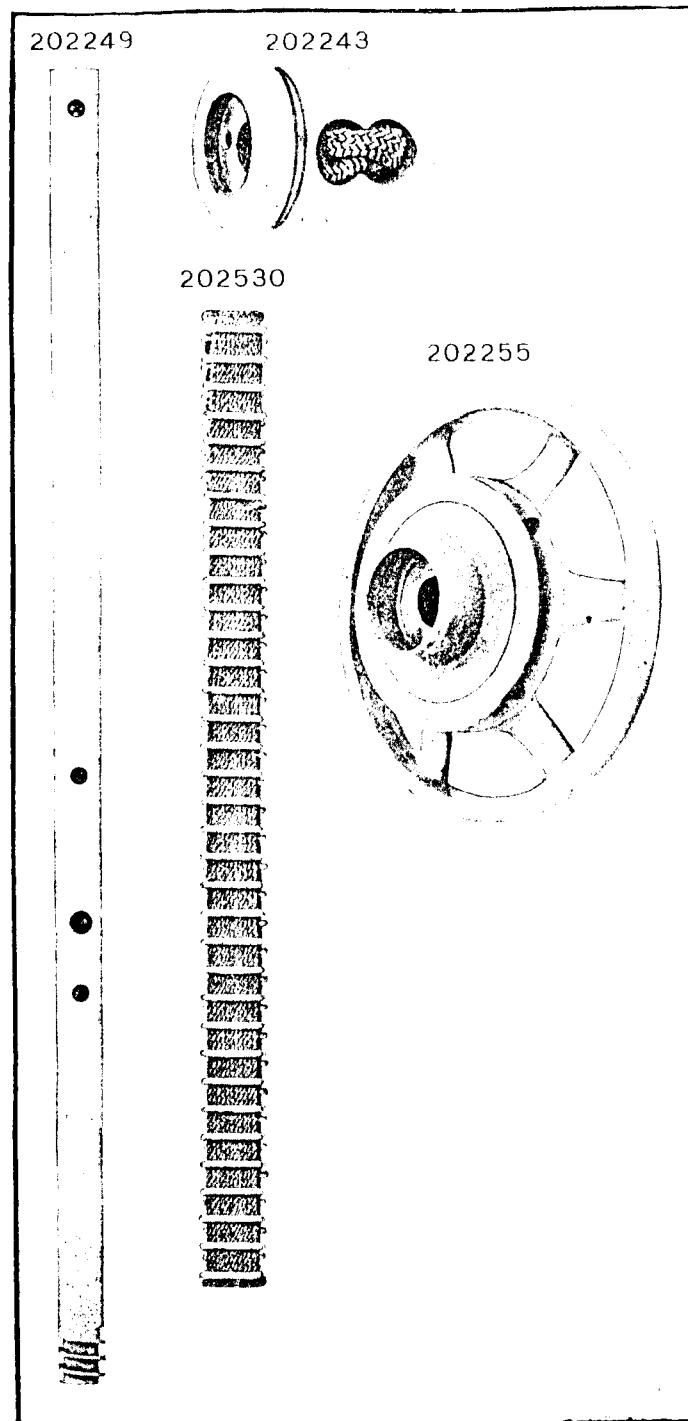


PLATE 13352—ONE-HALF SIZE

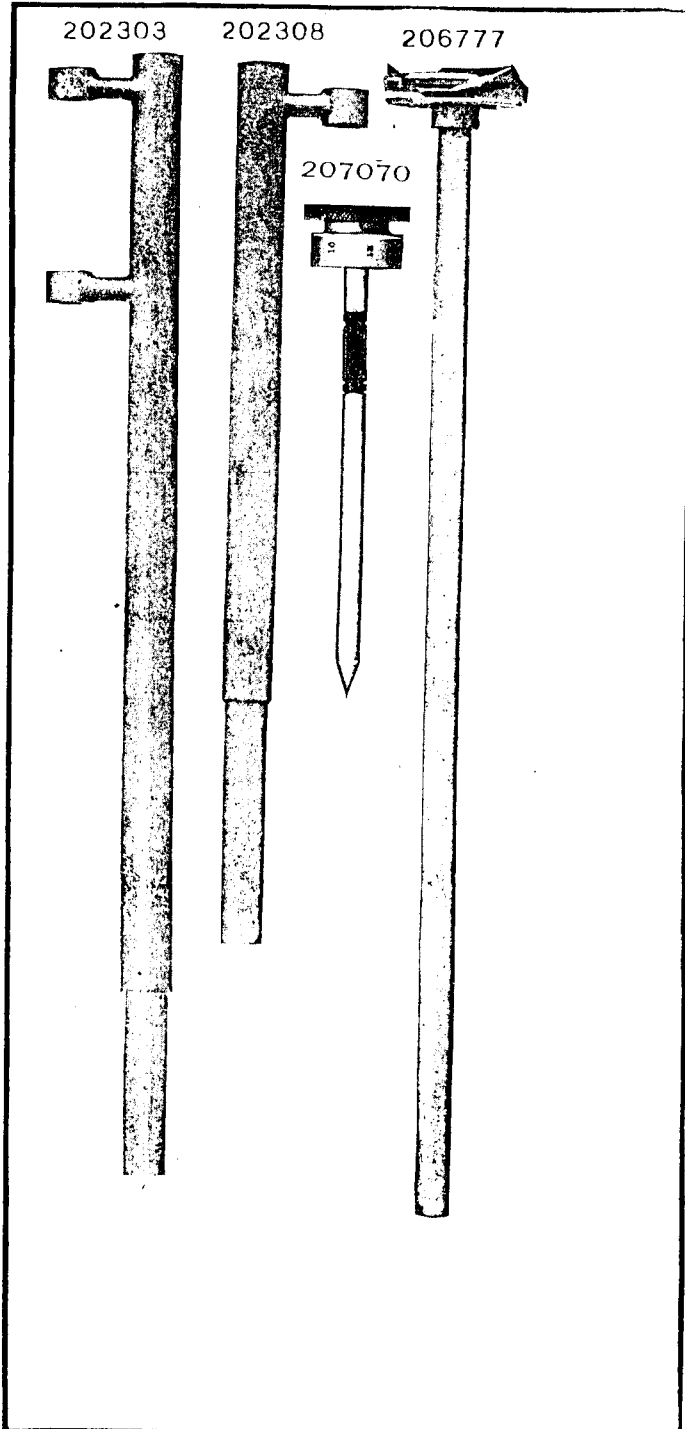
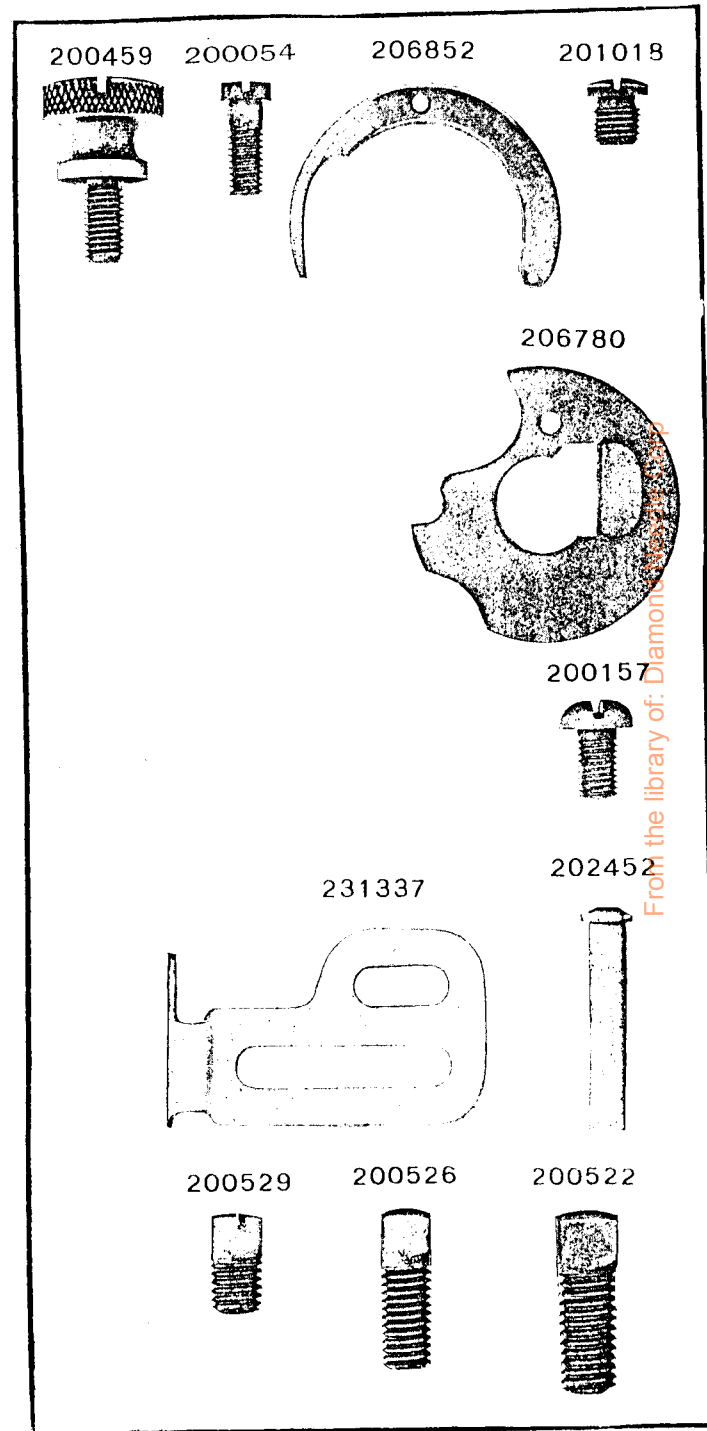


PLATE 13353—FULL SIZE



From the library of: [Diamonds.com](#)



PLATE 13363-FULL SIZE

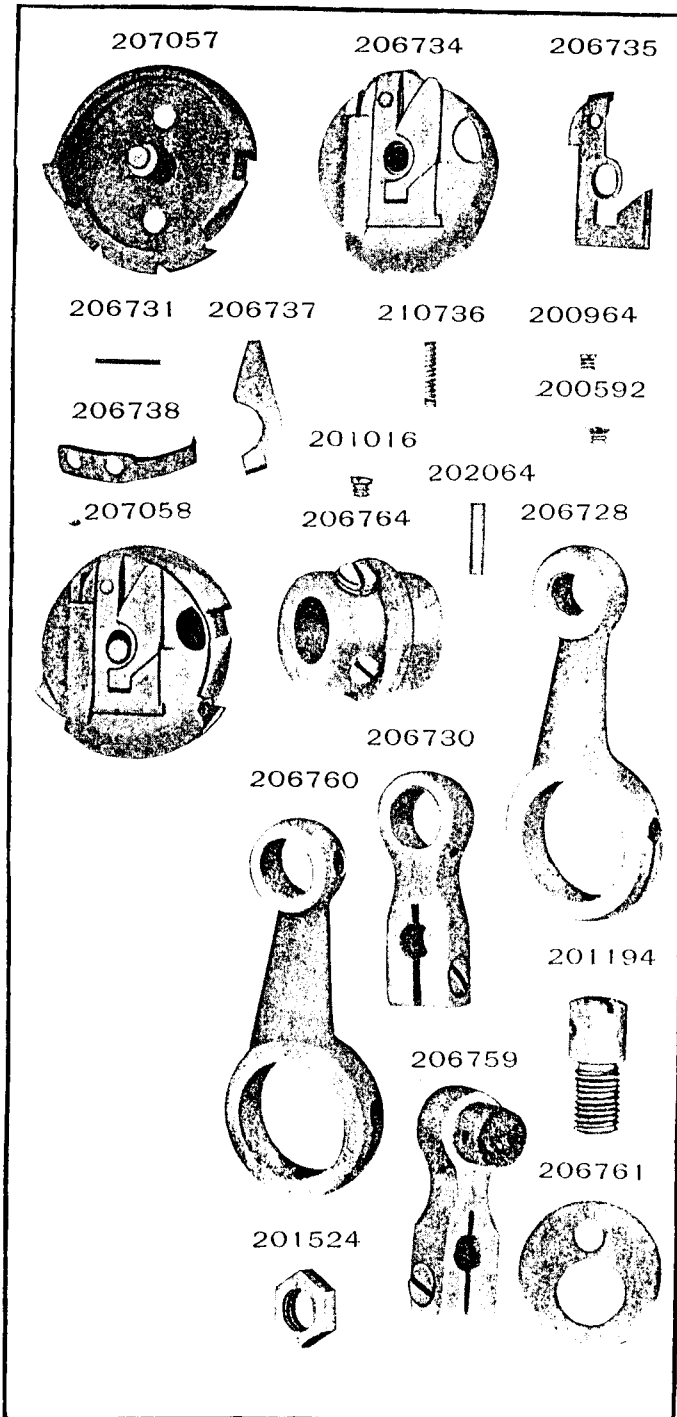


PLATE 13364-ONE-HALF SIZE

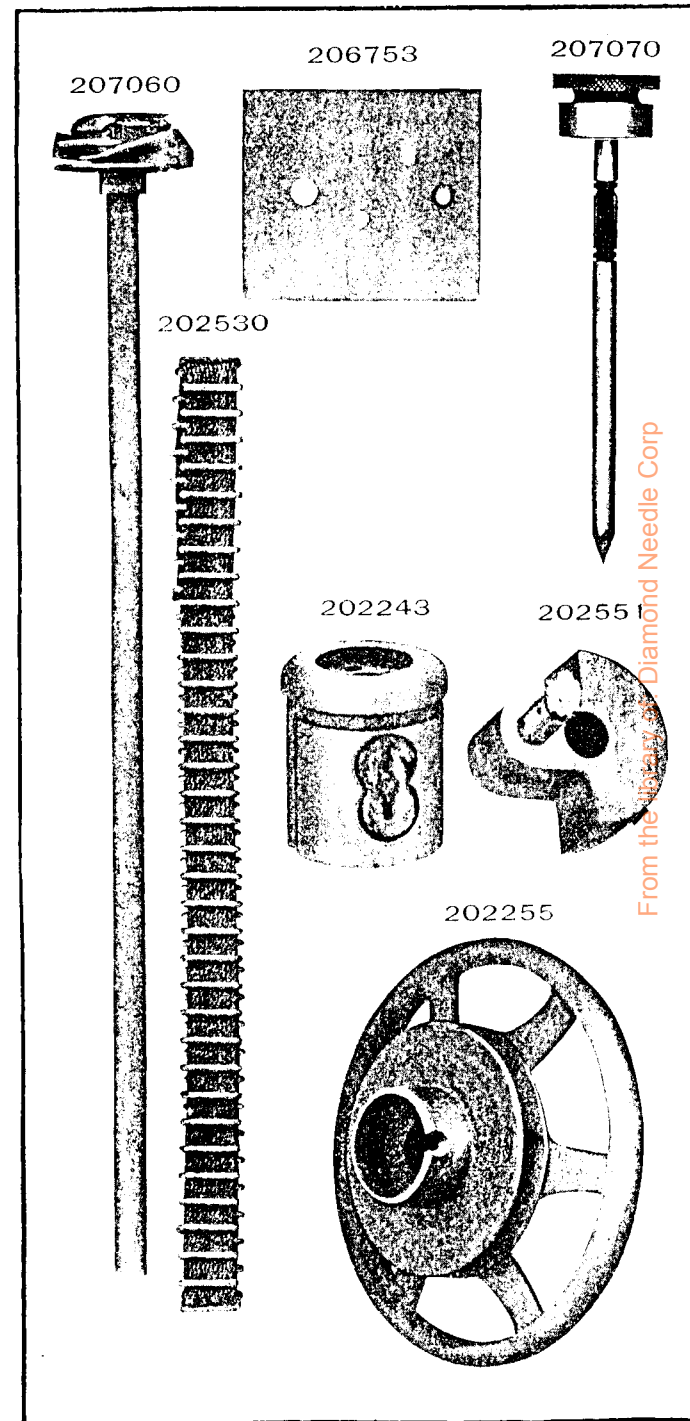
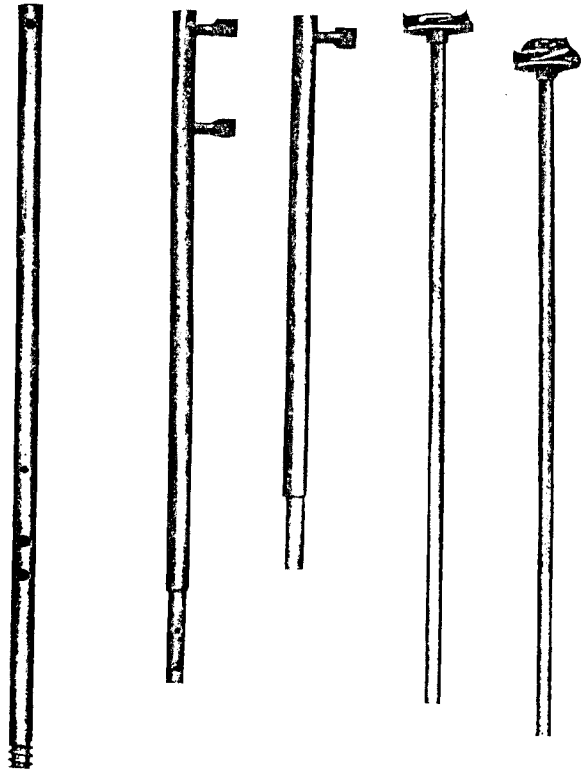


PLATE 13365-ONE-FOURTH SIZE

202250 202304 202654 206754 207061

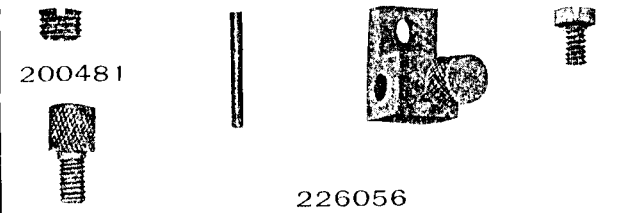


225663



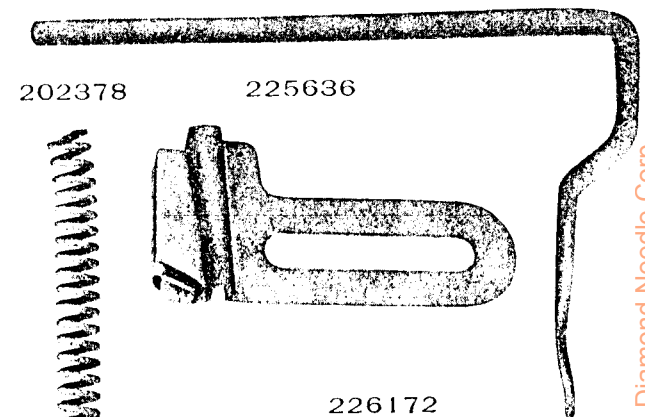
PLATE 13366-FULL SIZE

200382 202090 226057 200118



200481

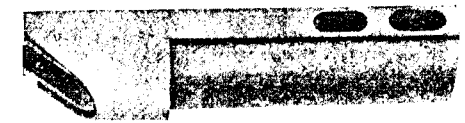
226056



202378

225636

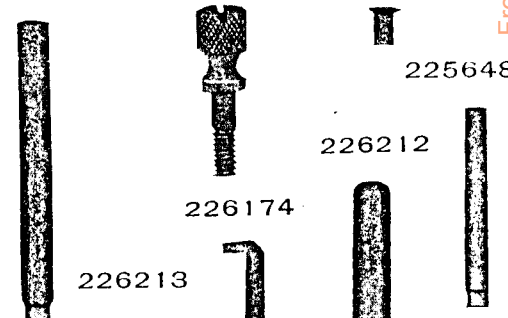
226172



225664

200896

205520

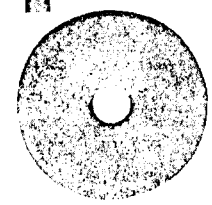


225648

226212

226174

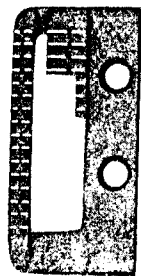
226213



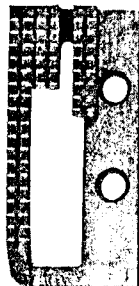
From the library of: Diamond Needle Corp

PLATE 13367-FULL SIZE

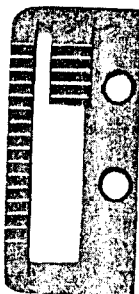
202286



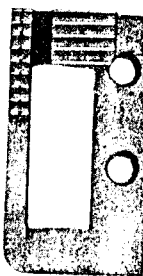
202288



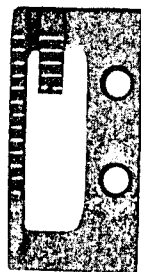
226171



230598



202284



226190

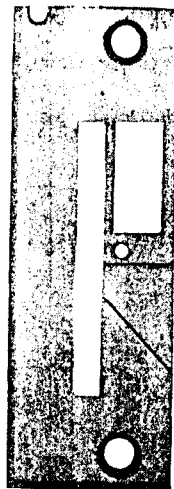
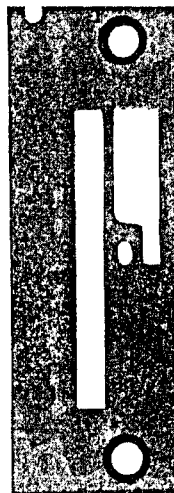
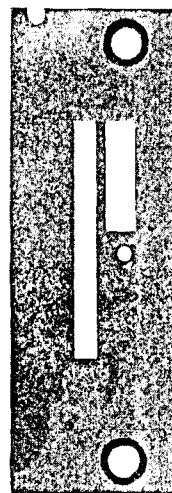


PLATE 13368-FULL SIZE

202826



202812



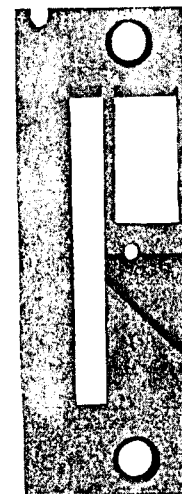
202821



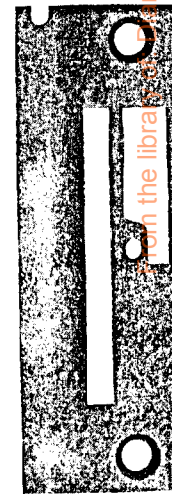
202823



203102



203198



From the library of the National Archives and Records Administration

PLATE 13369-FULL SIZE

229867



207024



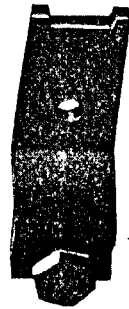
206830



206832



206998

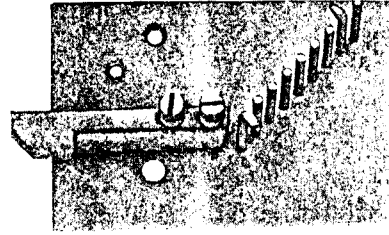


200543

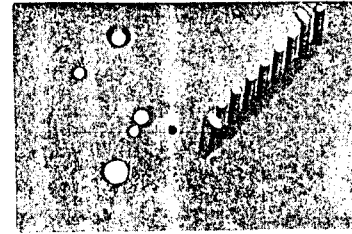


PLATE 13370-ONE-HALF SIZE

226173



230650



From the library of: Diamond Needle Corp